

Posizione <i>Position</i>	Descrizione <i>Description</i>	Materiale <i>Material</i>
1	Dado - Nut	AISI 304
2	Tirante - Tie-rod	AISI 304
3	Attacco - Connection	AISI 304/316 L
4	Guarnizione - Seal ring	Silicone VITON PTFE
5	Vetro PIREX - PIREX glass	PIREX
6	Protezione vetro - Protection glass	AISI 304

Specola visiva in linea
Sight glass flow indicator



Specola visiva in linea Sight glass flow indicator

COD. SPLTC...-4/6

Attacco clamp BS4825
BS4825 Clamp connection

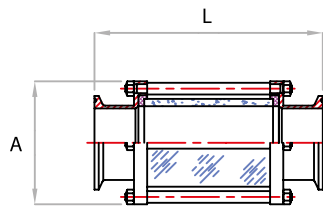

Ø	1/2"	3/4"	1"	1 1/2"	2"	2 1/2"	3"	4"
L	108	108	156	156	156	186	220	218
A	40	42	64	74	84	100	125	145

COD. SPLD...FF-4/6

Attacco DIN 11851 F/F
DIN 11851 F/F connection

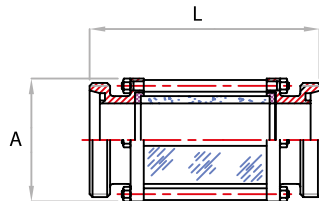

DN	25	32	40	50	65	80	100
l	158	158	158	158	188	236	240
a	64	70	74	84	99	125	145

COD. SPLD...SS-4/6

Attacco a saldare DIN
DIN weld connection

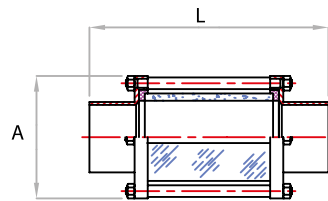

DN	25	32	40	50	65	80	100
l	164	164	164	164	190	224	224
a	64	70	74	84	99	125	145

COD. SPLD...MG/MG-4/6

Attacco masch./gir. DIN
Male connection

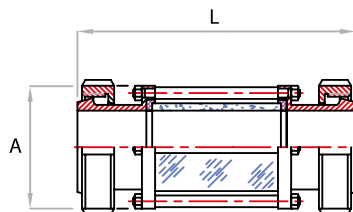

DN	25	32	40	50	65	80	100
L	160	160	162	174	204	240	244
A	64	70	74	84	99	125	145

COD. SPLD...FL/FL-4/6

Attacco flangiato PN6
PN6 flanged connection

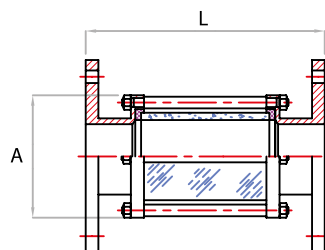

DN	25	32	40	50	65	80	100	120
L	162	162	162	166	196	248	248	325
A	64	70	74	84	99	125	145	178

COD. VSL-D...

Vetro borosilicato
per specola
Borosilicated sight glass

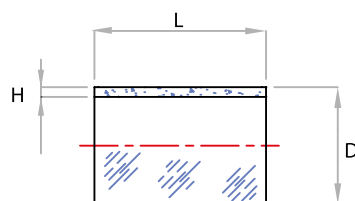

DN	25	32	40	50	65	80	100	125
D	32	40	50	60	75	90	110	140
L	90	90	90	90	120	150	150	200
H	2,8	3,2	5	5	5	5	6	7
P.bar	6	6	8	8	8	7	6	5
T°C	250	250	250	250	250	250	250	250



Posizione Position	Descrizione Description	Materiale Material
1	Premivetro / Lens cushion gasket	DELRIN
2	Guarnizione a labbro / Lip gasket	Silicone
	Guarnizione a richiesta / Gasket on request	PTFE - VITON
3	Raccordo femmina S./M. / Female connection	AISI 304/316 L
4	Vetro / Glass	Vetro PIREX
5	Girella / Nut	AISI 304

	DN	25	32	40	50	65	80	100	125	150
Misure Size	D	63	70	78	92	112	127	148	178	210
	L	38	42	42	46	50	57	66	57	65
	I	35	41	48	61	79	93	114	137	162
	E	26	32	38	50	66	81	98	125	150
Vetro Glass	∅	40	45	50	60	78	94	112	139	150
	Sp.	10	10	10	10	10	10	10	12	15
	P.bar	40	35	25	16	8	6	5	5	5
	T°C	150	150	150	150	150	150	150	150	150

COD. SPD...S-6

Specola piana
Flat sight glasses

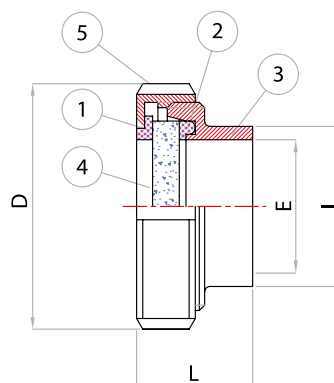

Specola visiva piana
Flat sight glasses

Posizione Position	Descrizione Description	Materiale Material
1	Premivetro / Lens cushion gasket	AISI 304
2	Guarnizione / Gasket	Silicone
3	Anello / Ring	PTFE
4	Vetro / Glass	Vetro PIREX
5	Tronchetto Clamp / Clamp pipe	AISI 316
6	Morsetto / Clamp	AISI 304

Misure TC Size	1"1/2	2"	2"1/2	3"	4"
L	42	43	44	44	46

COD. SP-TC_-CC6

Specola piana clamp
Clamp flat sight glasses

